

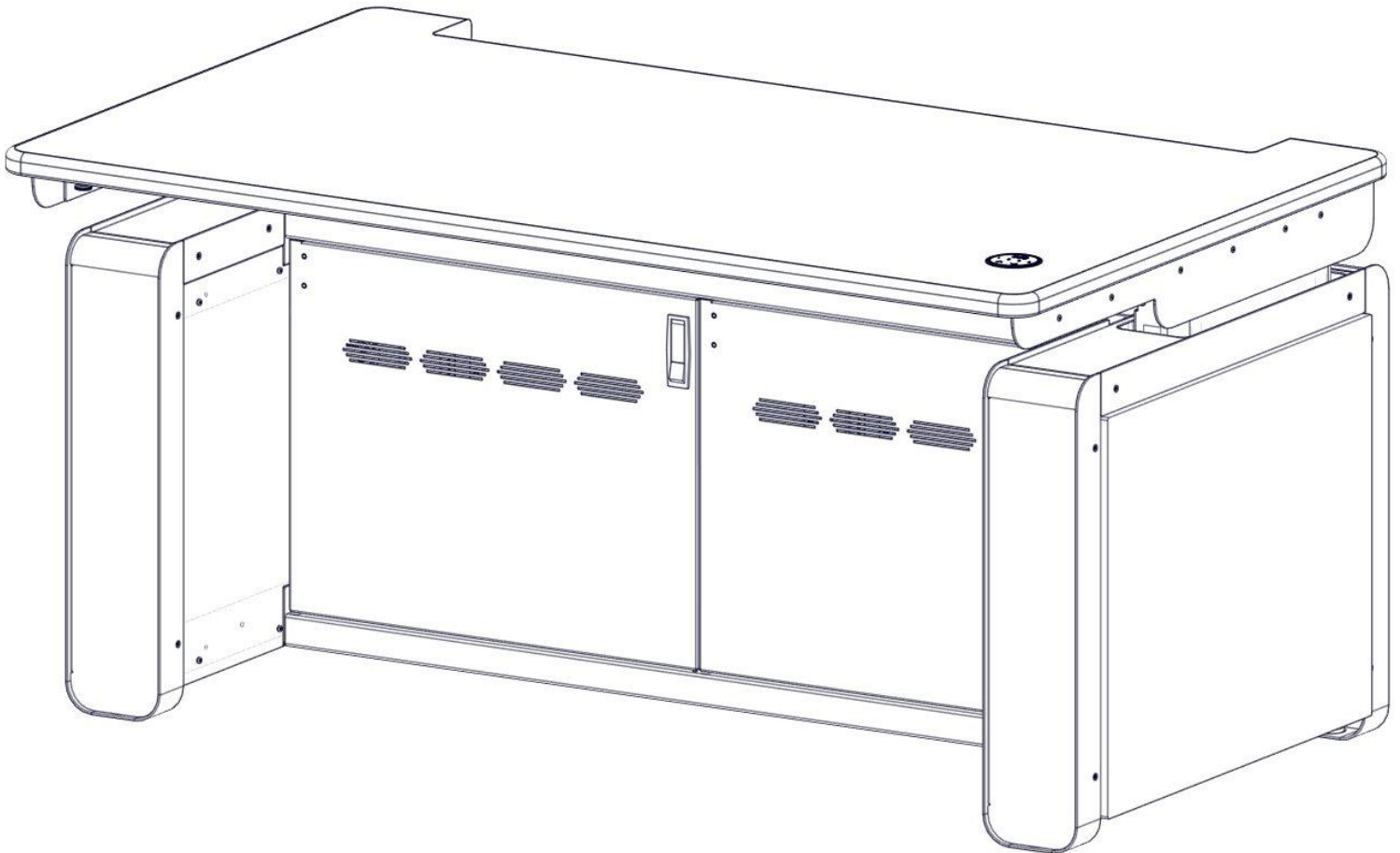

95176

PINNACLE 60"



PARTS

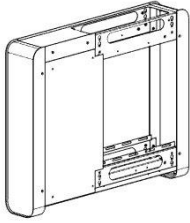

95000 (2x)

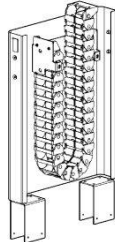

95162 (2x)



75000 (4x)



95056 (2x)



95154 (3x)

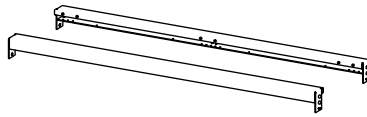

95155 (2x)

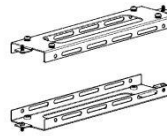

95151 (1x)

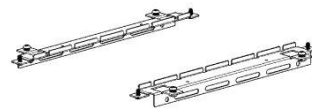

95152 (2x)

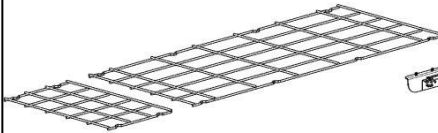

95021 (2x)

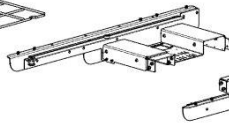

95020 (5x)

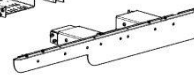

95135 (1x)

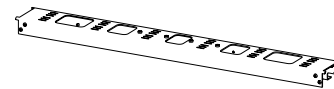

95166 (1x)

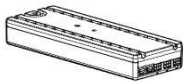

95008 (1x)



57710 (4x)

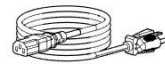

57703 (1x)



10590 (1x)

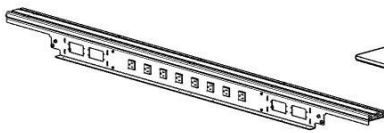

95141 (1x)

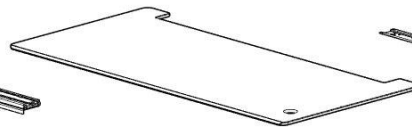

95173 (1x)



95137 (1x)



95082 (1x)



95009 (1x)



95145 (1x)



95068 (2x)









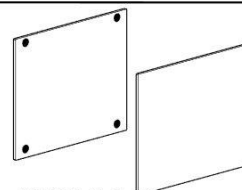











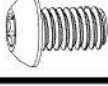



59056 (4x)



95022 (2x)



95165 (1x)

	HARDWARE	NAME	
A		M8x1.25mm 8mmL LOW PROFILE	 5mm
B		M6x1.0mm 16mmL TORX BUTTON HEAD	 T 30
C		M4x0.7mm 10mmL THREAD FORMING	 T 20
D		M4x0.7mm 10mmL TORX FLAT HEAD	 T 20
E		M6x1.0mm 10mmL TORX BUTTON HEAD	 T 30
F		M6x1.0mm 45mmL TORX BUTTON HEAD	 T 30
G		M8x1.25mm 25mmL LOW PROFILE	 5mm
H		#10x0.750in WOOD SCREW	 #2
I		M4x0.7mm 10mmL TORX PAN HEAD	 T 20
J		MOUNTING BOLT	 #2
K		M3x0.5mm 4.5mmL SLOTTED	

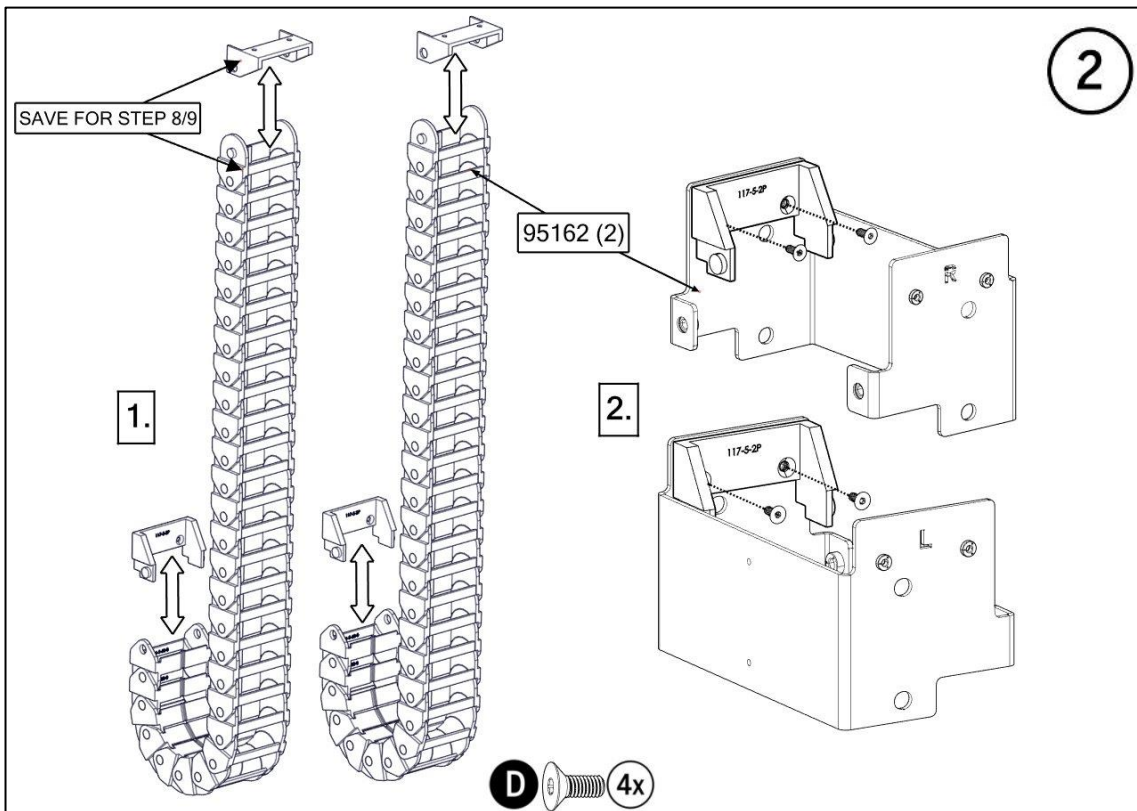
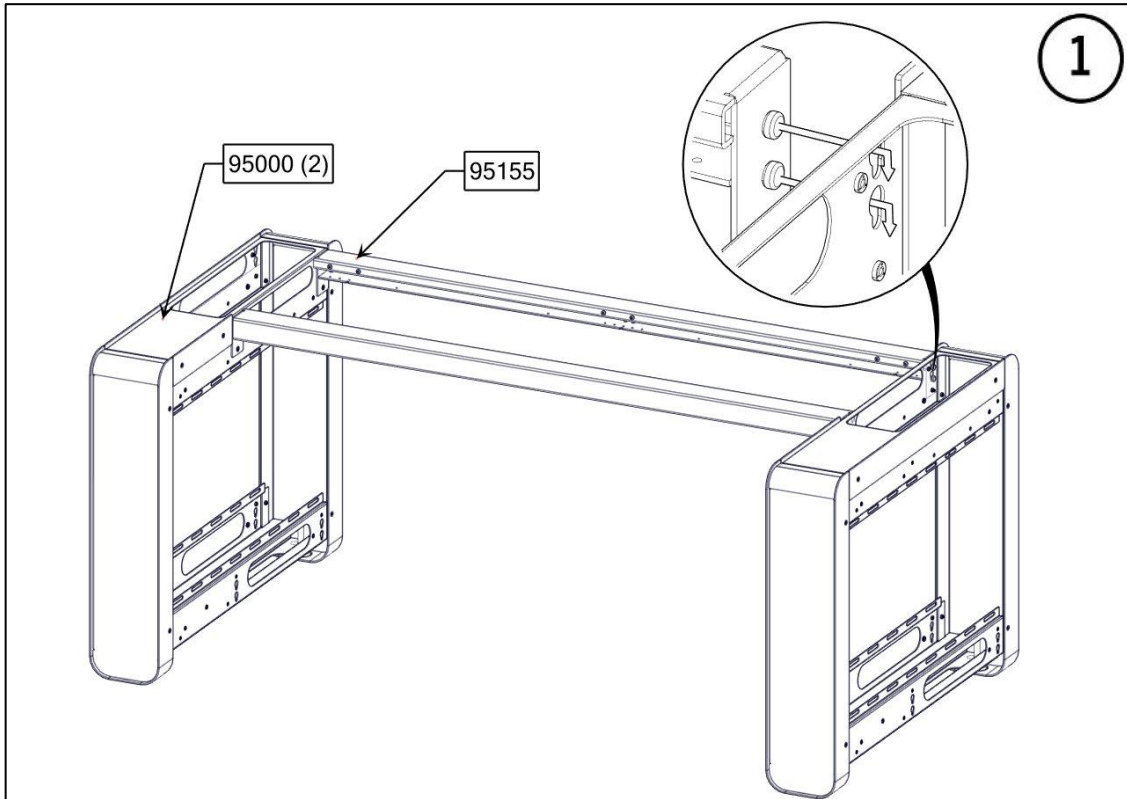

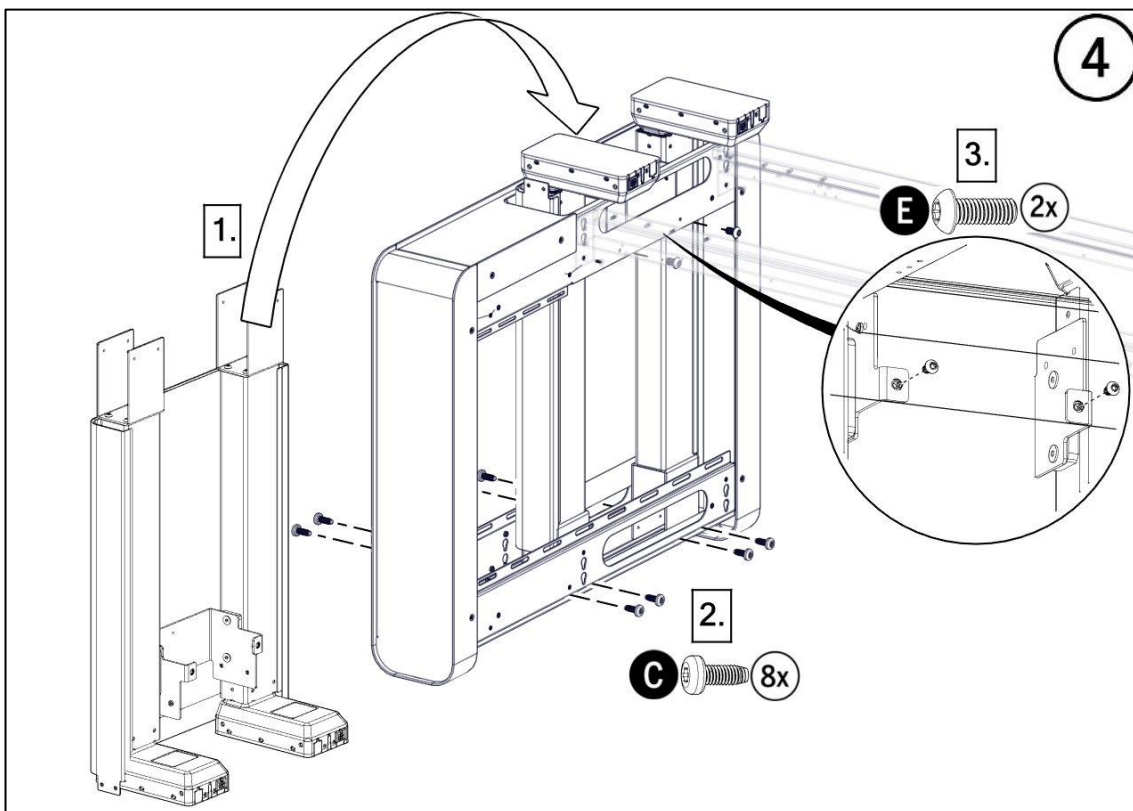
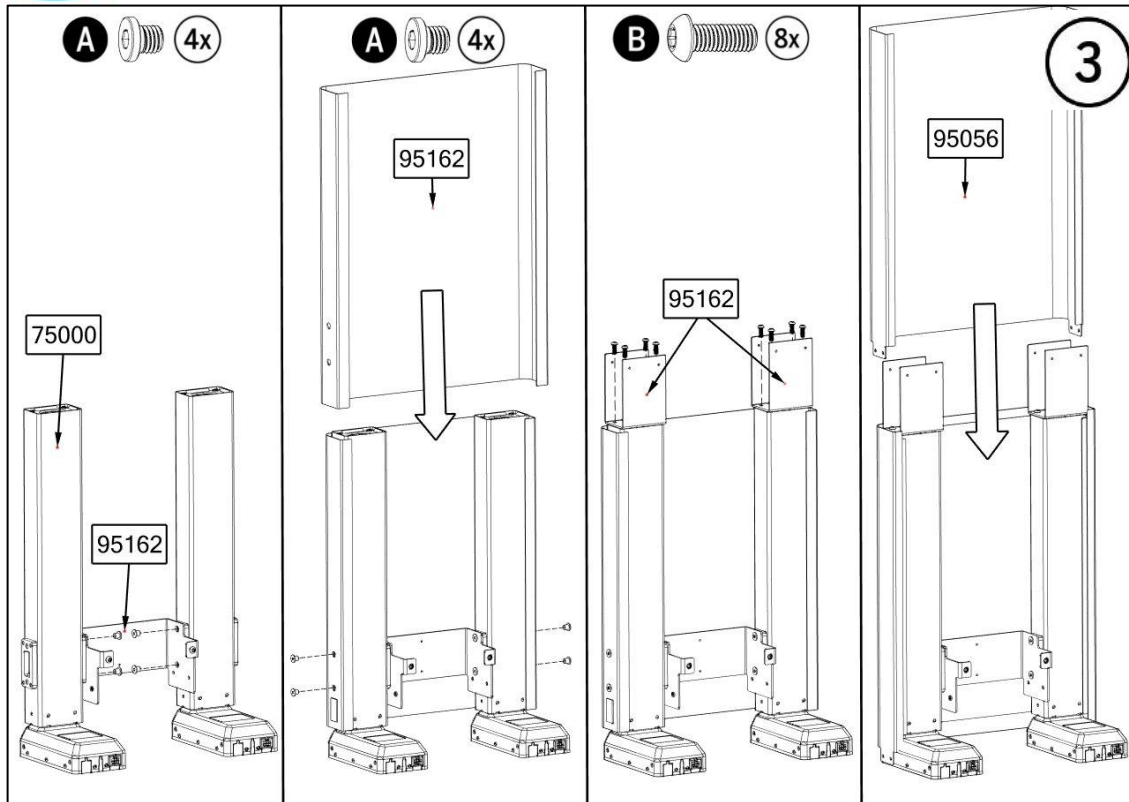

Screws may need to be loosened first

5

1.

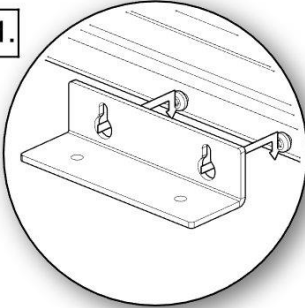

2.

